

SSPC is our new stainless steel fittings line. Suitable for all those applications where brass nickel-plated and acetal fittings are banned, the new AISI 316L fitting is conceived to withstand corrosive environments (substances), to channel aggressive fluids and to be used in the food and chemical industries.

SSPC is standardly equipped with FPM seals that will assure endurance at the highest temperatures.

DATA SHEET

Recommended hoses: PVDF, PTFE.

Acceptable Tubing Tolerances:

O.D. TUBE	O.D. TUBE TOLERANCES
1/8 to 3/16	+ .002 (+ 0.05 mm) - .003 (- 0.07 mm)
1/4 to 1/2	+ .002 (+ 0.05 mm) - .004 (- 0.1 mm)

Allowed pressure range: Pressure varies depending on the kind of tubing used and in any case it never has to exceed 217 P.S.I. In case of application with fluids, please follow instructions below:

Constant Pressure: Max Pressure: 217 P.S.I.

Pulse Pressure: Max Pressure: 145 P.S.I.

Vacuum: up to 750 mmHg

Acceptable working temperature range: -4°F H- 302°F depending on the materials and the tube diameters used.

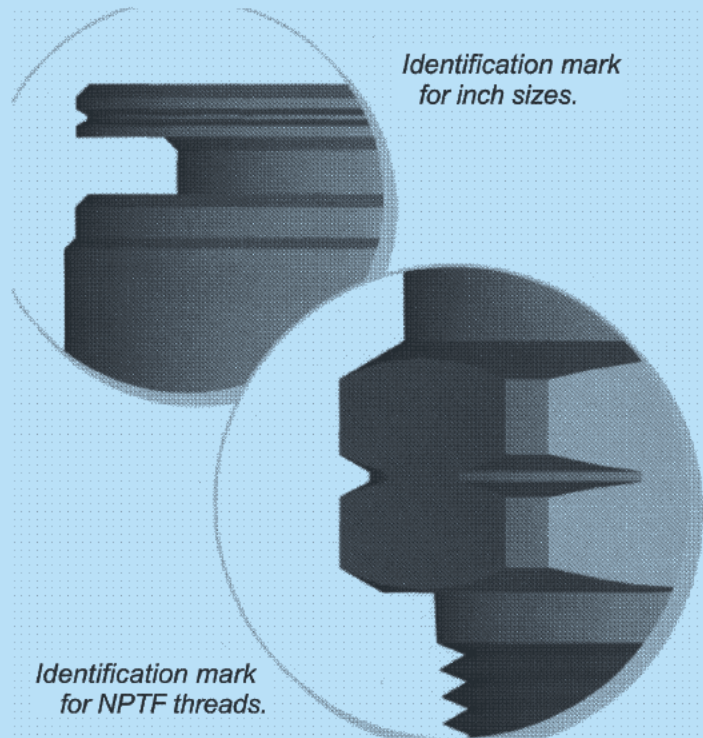
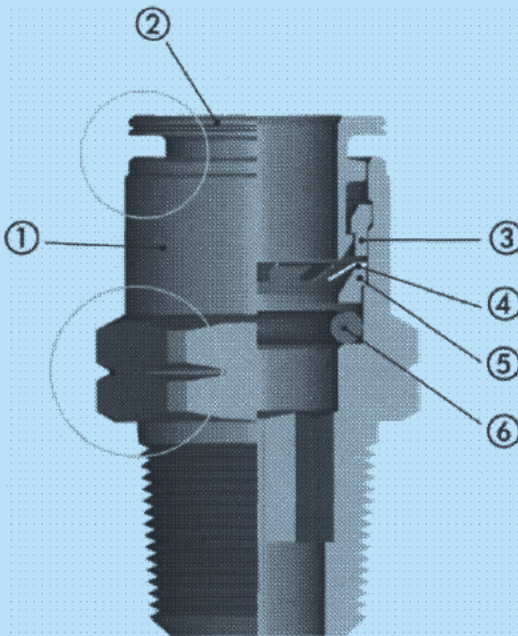

- ① **BODY:** Stainless steel AISI 316L
- ② **RELEASE RING:** Stainless steel AISI 316L
- ③ **TIGHTNESS RING:** Stainless steel AISI 316L

- ④ **GRIPPING COLLET:** Stainless steel AISI 301
- ⑤ **PROTECTION RING:** Stainless steel AISI 316L
- ⑥ **O-RING:** FPM/FKM

STAINLESS STEEL PUSH CONNECT



SSPC-2403 - Str.
(1) (2) Tube Union

SSPC-2403-04-04	89.55
SSPC-2403-05-05	103.42
SSPC-2403-06-06	79.95
SSPC-2403-08-08	185.65
SSPC-2403-5/32-5/32	91.25

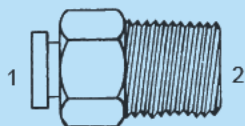

SSPC-2404 - Str.
(1) Tube
(2) Male Pipe

SSPC-2404-04-02	79.95
SSPC-2404-04-04	84.80
SSPC-2404-05-04	88.67
SSPC-2404-06-04	103.75
SSPC-2404-06-06	109.70
SSPC-2404-08-06	142.31
SSPC-2404-08-08	155.10
SSPC-2404-5/32-02	68.67



SSPC-2406 - Str.
(1) Tube
(2) Stem

SSPC-2406-04-05	130.27
SSPC-2406-05-06	137.36
SSPC-2406-5/32-04	100.91

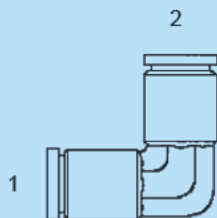

SSPC-2500 - 90°
(1) (2) Tube Union

SSPC-2500-04-04	114.95
SSPC-2500-05-05	152.02
SSPC-2500-06-06	194.40
SSPC-2500-08-08	241.91
SSPC-2500-5/32-5/32	122.92

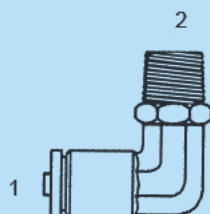

SSPC-2501-S - 90°
(1) Tube
(2) Male Pipe Swivel

SSPC-2501-S-04-02	120.35
SSPC-2501-S-04-04	139.90
SSPC-2501-S-05-04	180.92
SSPC-2501-S-06-04	215.75
SSPC-2501-S-06-06	232.05
SSPC-2501-S-08-06	280.06
SSPC-2501-S-08-08	290.90
SSPC-2501-S-5/32-02	161.58

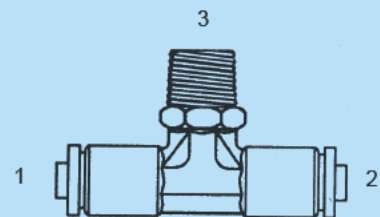

SSPC-2601-S - Tee
(1) (2) Tube
(3) Male Pipe Swivel

SSPC-2601-S-04-04-02	210.59
SSPC-2601-S-04-04-04	215.04
SSPC-2601-S-05-05-04	260.58
SSPC-2601-S-06-06-04	330.07
SSPC-2601-S-06-06-06	347.42
SSPC-2601-S-5/32-5/32-02	187.17

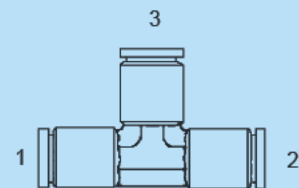

SSPC-2603 - Tee
(1) (2) (3) Tube

SSPC-2603-04-04-04	156.30
SSPC-2603-05-05-05	200.25
SSPC-2603-06-06-06	247.15
SSPC-2603-08-08-08	327.34
SSPC-2603-5/32-5/32-5/32	159.83

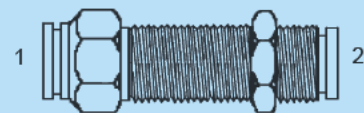

SSPC-2700-LN - Tee
(1) Tube
(2) Bulkhead Tube

SSPC-2700-LN-04-04	296.85
SSPC-2700-LN-06-06	320.31
SSPC-2700-LN-08-08	366.62